

JANUARY 2024

COMPANY OVERVIEW

Garrett
ADVANCING MOTION

Guidelines and Instructions

- This presentation contains detailed information about **Garrett Motion** worldwide. It is intended for external audiences.
- You are not permitted to release any Garrett business, industrial or financial information other than those listed in this presentation.
- You can copy/paste the slides you need and build a customized deck but please do not modify the slides.
- You may leave a printed copy of this presentation to your customers. If ever they request an electronic copy, please hand out a PDF copy only.
- Our holding company name is **Garrett Motion Inc.** When stating our company name in text, please use **Garrett Motion** the first time and then use **Garrett** only. **No acronym is allowed.**
- Garrett's Nasdaq stock market symbol is **GTX**. The stock exchange symbol is to be used only in connection with the company's Nasdaq listing and not as an abbreviation of the company name.
- The use of the letter 'G' as a standalone symbol is not permitted.

WHO WE ARE



Our Garrett mission

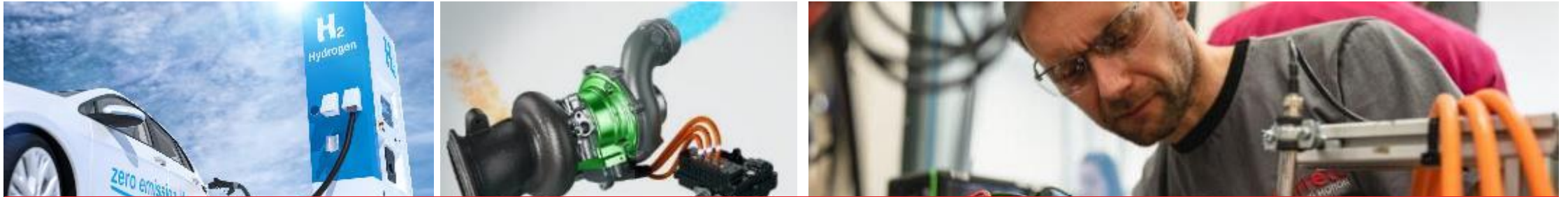

Garrett is a cutting-edge technology leader delivering differentiated solutions for emission reduction and energy efficiency.

We are passionate about innovating for mobility and beyond.



Garrett at a glance

\$3.6B
Revenue in 2022

~9,300¹
Employees

~1,250
Engineers

40+
Vehicle manufacturers
served globally

5
R&D centers

11
“Close-to-customer”
engineering centers

5
Software development
centers

13
State-of-the-art
manufacturing facilities

~1,700
Patents issued or pending

\$100M+
Annual Investment in Electrification

50,000+
Turbos / day

120M+
Garrett turbos in use globally

¹ Includes approximately 7,300 permanent employees and 2,000 temporary and contract workers globally as of 12/31/2022

Global Leader and Innovation Powerhouse

2022 Revenue Breakdown



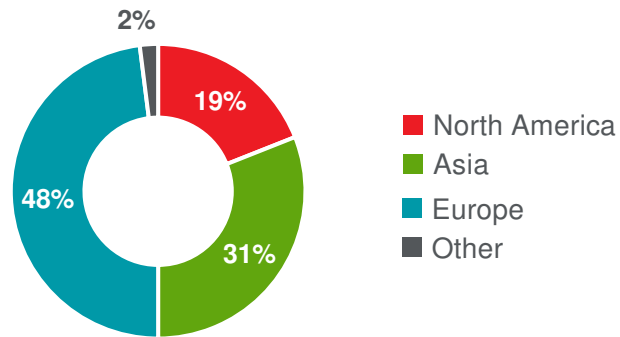



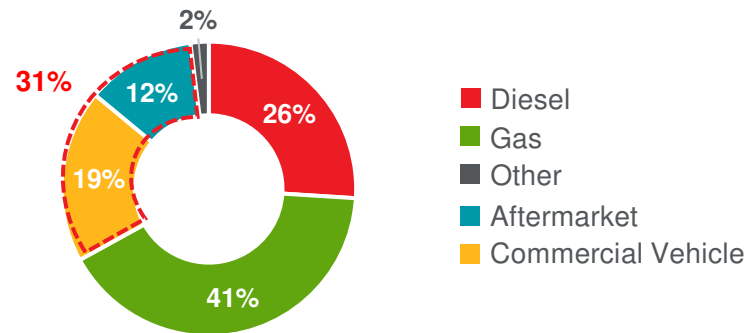



By Geography



By Product Line



Technologies Offering

Emission Reduction	<i>Commercial Vehicle & Industrial</i>		
	 Large Free-Float	 Double Axle VNT	 Wastegate
Zero Emission	<i>Light Vehicle Diesel, Gas & Hybrid</i>		
	 Wastegate	 Variable Nozzle Turbine (VNT)	 Two Stage
	 E-Turbo	 E-Compressor	
	 Fuel Cell Compressor	 E-Powertrain	 E-Cooling Compressor

Decarbonizing mobility for 40+ global customers

All images are embedding Garrett products currently in production

Light Vehicles



Racing & Special Vehicles



On-highway commercial vehicles



First Garrett Turbo application in 1954 

Off-highway commercial vehicles & Industrials



Global footprint, local player

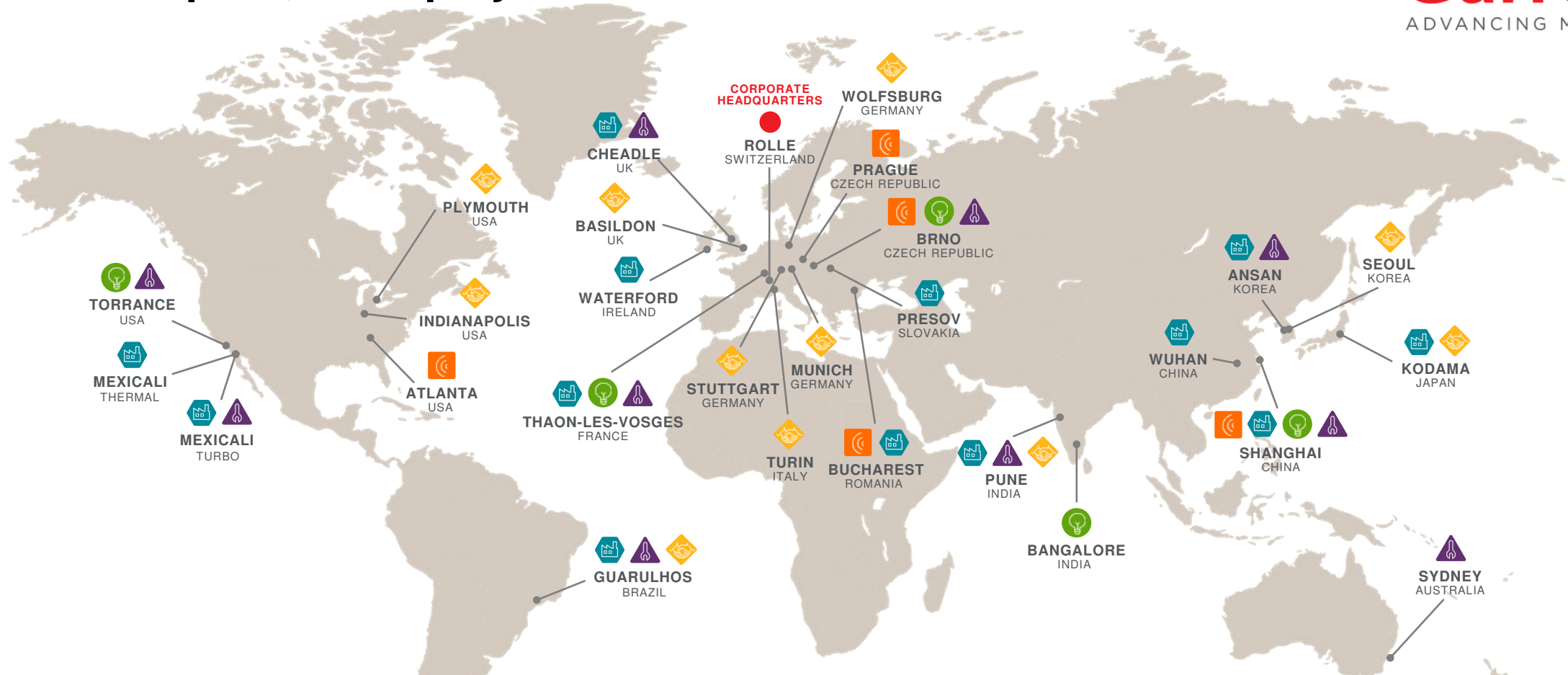

				
STATE-OF-THE-ART MANUFACTURING PLANT	SOFTWARE DEVELOPMENT CENTER	R&D CENTER	AFTERMARKET CENTER	CLOSE-TO-CUSTOMER ENGINEERING CENTER

Differentiated integrated supply chain strategy



Differentiated internal manufacturing technologies

- Home-grown “industry firsts” (including high-speed electron-beam, laser welding and more)
- Proprietary super high-speed balancing
- 100+ manufacturing patents and trade secrets

Standardized manufacturing processes

- Global engine programs sourced from multiple plants
- Maximized flexibility and assets utilization
- Resilience to industrial risks

13

State-of-the-art manufacturing facilities

50,000+

Turbos / day



















100+

New applications annually

Long-term customer relationships with 40+ manufacturers



SINGLE SUPPLIER PER ENGINE
20+ YEARS CYCLE

 68 YEARS	 37 YEARS	 29 YEARS	 38 YEARS	 29 YEARS	 13 YEARS	 24 YEARS	 25 YEARS	 35 YEARS
 40 YEARS	 40 YEARS	 34 YEARS	 30 YEARS	 29 YEARS	 29 YEARS	 33 YEARS	 43 YEARS	 17 YEARS

TECHNOLOGY DIFFERENTIATION



68 years of advancing motion

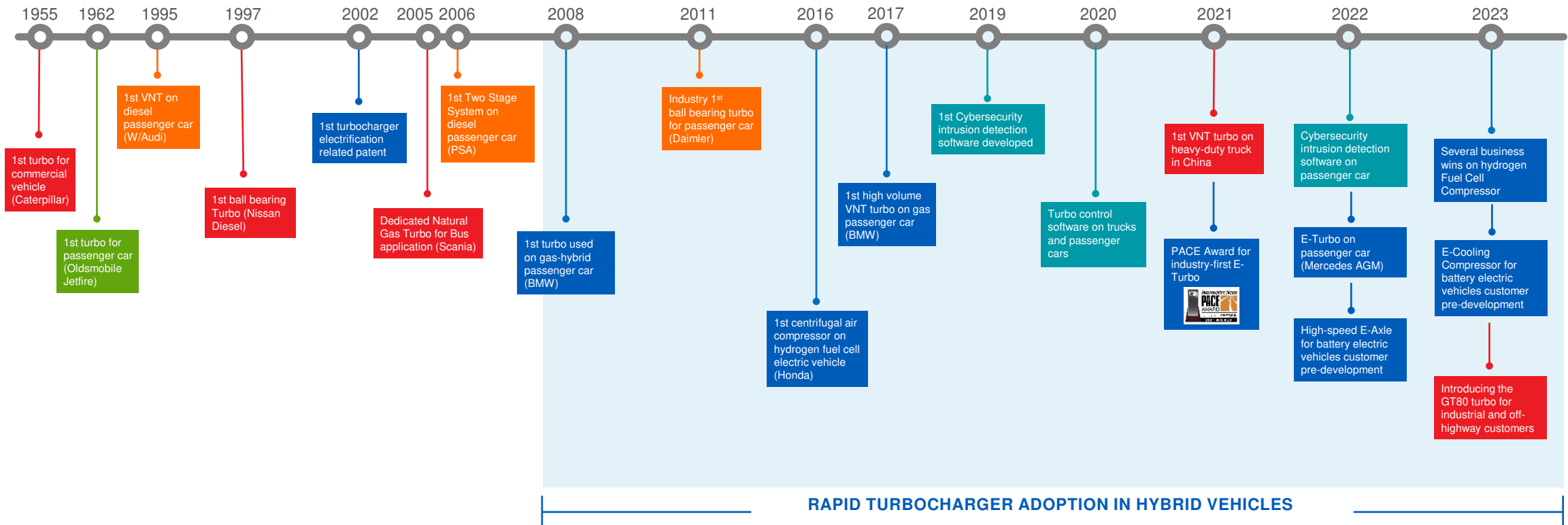

Note: **WG** – Wastegate turbine (fixed geometry) **VNT** – Variable Nozzle Turbine
EGR – Exhaust gas recirculation **IVHM** – Integrated Vehicle Health Management

Garrett turbocharging is technology at the cutting edge

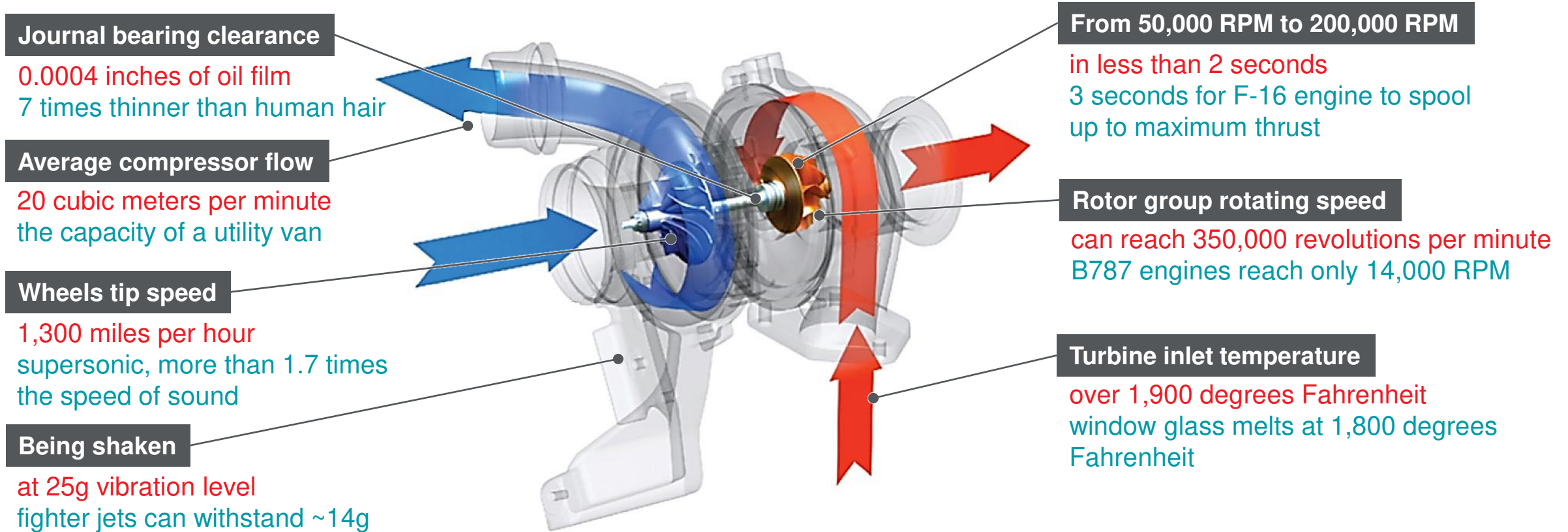

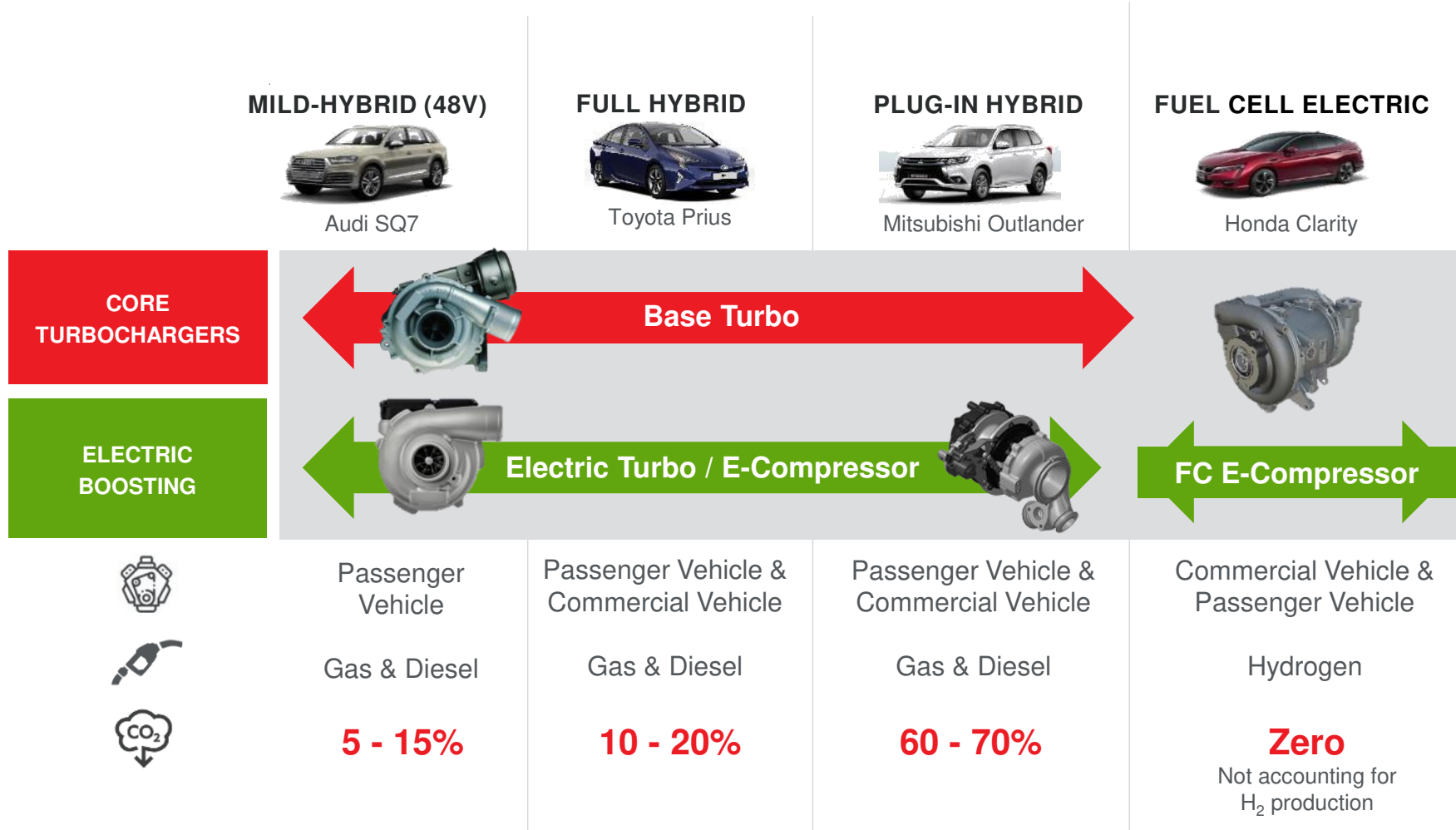

Turbocharging electrified powertrains



- **76% hybrid and 100% hydrogen fuel cell powertrains turbocharged by 2025**
- **Full CO₂ potential unlocked** with electric boosting
- **Hydrogen fuel cell electric vehicles require high performance E-Compressor**

Garrett electric boosting offering







	ELECTRIC COMPRESSOR Mild, Full and Plug-in Hybrids	ELECTRIC TURBO Mild, Full and Plug-in Hybrids	TWO STAGE ELECTRIC COMPRESSOR Fuel Cell Electric
			
CUSTOMER BENEFITS	<ul style="list-style-type: none"> • Full speed within 0.25s • 2-3% better fuel economy • 20% NOx reduction (Diesel) • Enables Lambda 1 (Gasoline) 	<ul style="list-style-type: none"> • 4x faster than a conventional turbo • 2-4% better fuel economy (regen) • 20% NOx reduction (Diesel) • Enables Lambda 1 (Gasoline) 	<ul style="list-style-type: none"> • Enables 40% downsizing of fuel cell stack • Reduces volume, weight and cost • Optimal power consumption due to architecture & high-efficiency design
GARRETT EXPERIENCE	<ul style="list-style-type: none"> • Specific aerodynamics • High-speed electric machines • System integration 	<ul style="list-style-type: none"> • System packaging • High-speed electric machines • Boost and energy management 	<ul style="list-style-type: none"> • Innovative high-efficiency aerodynamics • High-speed electric machines • Air bearing
ARCHITECTURE	<ul style="list-style-type: none"> • Aerodynamics and motor matched for optimal speed • Sealed for life bearings 	<ul style="list-style-type: none"> • Integrated turbo & high-speed motor/generator • Stand alone or Integrated Power Electronics 	<ul style="list-style-type: none"> • Two Stage series compressors • 100% oil-free foil bearing technology to avoid pollution of fuel cell stack with oil and provide the lowest noise & vibration possible

Garrett light & commercial vehicle turbo technologies





- Dedicated engineering support
- Fuel efficiency through state-of-the-art aerodynamics, bearing systems and control
- Higher performance, better fuel economy and emissions control enabled by innovative variable nozzle turbine designs
- Optimized for transient behavior to improve drivability and enhance driving pleasure

Offering the broadest portfolio for every vehicle type

FREE-FLOAT	WASTEGATE	VARIABLE NOZZLE TURBINE (VNT™)	
			
DOUBLE AXLE VNT	TWO STAGE	TURBO-COMPOUNDING	ELECTRIC BOOSTING
			

Core competencies enable successful Innovation shift

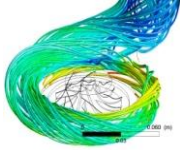
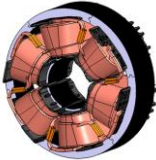
Garrett's unique capabilities advance technologies for electrified vehicles

Turbomachines for Air Compression	High-Speed Motors	Power Electronics	Control Software
 <p>High precision design & assembly, high speed balancing, and ability to operate in harsh environments across multiple use cases</p> <p>▼</p> <p>Withstands temperatures up to 1,200° Celsius (1,900° F). Operating with tolerance 7x thinner than hair</p>	 <p>Best-in-class power density, producing the same amount of power in a smaller, more compact form</p> <p>▼</p> <p>Garrett E-Turbo e-motor can rotate in excess of 200,000 RPM. Operating at 10x typical automotive speeds</p>	 <p>Unique, compact design for high speed / high power motor control, operating in harsh environments (vibration, temperature)</p> <p>▼</p> <p>High voltage 400-800V electronics at industry-leading 30kHz switching frequency</p>	 <p>Use on-board digital twins to optimize energy efficiency of all vehicle types in real-time</p> <p>▼</p> <p>Up to 30x smaller memory footprint and up to 6x faster execution time vs. closest competitor</p>
✓ In-house design	✓ In-house design	✓ In-house design	✓ In-house design

Garrett Technologies for Zero Emission Vehicles

Hydrogen Fuel Cell EV (“FCEV”)

Battery EV (“BEV”)



Fuel Cell Compressor for Hydrogen Vehicles
Feeds the fuel cell stack with the air needed to generate electricity



E-Powertrain for Electric Vehicles
Integrated E-motor, inverter (power electronics) and transmission solution for EV propulsion

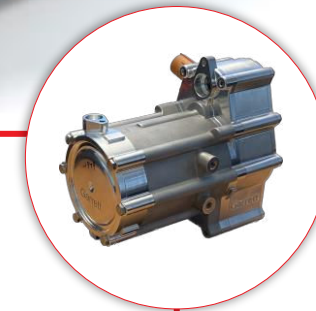
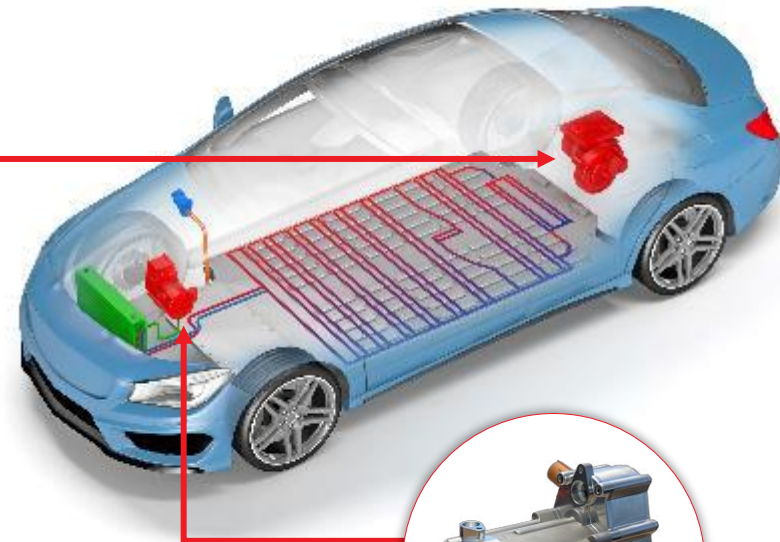

E-Cooling Compressor for Electric Vehicles
Crucial component in EV thermal management; circulates refrigerant fluid to cool the battery, E-Powertrain and cabin

Strong Zero Emission Vehicles Technologies pipeline

Delivering best-in-class technologies

Fuel Cell Compressor



Efficient and durable

- ✓ High-speed Air Compressor system... bringing best in class efficiency and durability
- ✓ 3rd generation; technology more mature versus competitors
- ✓ Downsizing fuel stack and reduced weight

High Speed E-Powertrain



Higher power, Smaller package

- ✓ Designed to re-set benchmark... via best-in-class Power Density
- ✓ Small packaging leaves more room for battery and / or cabin space,
- ✓ Reduced weight and rare earth metals used

E-Cooling



Step change in cooling and heating power for thermal management

- ✓ A new refrigerant compressor technology... bringing breakthrough performance
- ✓ Reduced power consumption enables vehicle range increase / reduces battery size
- ✓ Reduced noise levels



MULTIPLYING COMPLEXITY

Internal Combustion Engine
Aftertreatment + E-boosting + . . .



Electrified Powertrain
Hybridization + battery SOC/SOH, etc.



Autonomy
Sensors + actuations + . . .



Connected
Threat surfaces + updates + . . .

UNSOLVED CHALLENGES

Optimize complex systems

Validate for real-world

Ensure in-use compliance

Detect health degradation

Diagnose accurately

Differentiate fault vs. hack

GARRETT SOLUTIONS AND DIFFERENTIATORS



Advanced Controls and System Optimization

We solve complex automotive challenges, advancing controls technology

- Fuel, energy and emissions optimization
- Reduced development time
- Best-in-class algorithms and performance
- *Industrial process controls heritage*
- *+30 patents*
- *In production*



Advanced Diagnostic and Prognostic

We make complex diagnostic simple, advancing vehicle health management technology

- Improved first time right diagnostic accuracy
- Reduction of warranty and labor costs
- Improved fleet uptime and customer satisfaction
- *Aircraft health management heritage*
- *25+ patents*
- *In production*



Cybersecurity

We make connected cars cyber resilient and compliant, advancing vehicle security

- Best-in-class detection rate and false positive
- Best-in-class on-board footprint
- Holistic off board forensic capabilities
- *Industrial security management heritage*
- *50+ proprietary algorithms*
- *SOP 2021*

AFTERMARKET



Strong aftermarket platform with brand equity

Broad aftermarket product portfolio

<p>ORIGINAL EQUIPMENT / INDEPENDENT AFTERMARKET</p>		<ul style="list-style-type: none"> • Original supply ensuring emission compliance • Distributors network
<p>REMANUFACTURE</p>		<ul style="list-style-type: none"> • Remanufacturing of OE design • Economic alternative with no trade-off on quality/durability
<p>RED BOOST</p>		<ul style="list-style-type: none"> • Economic turbo for high growth regions, with good reliability • Original production line, portfolio expansion
<p>PERFORMANCE & MOTORSPORTS</p>		<ul style="list-style-type: none"> • Higher power, with reliability • 50+ years of racing support

#1 in global brand awareness

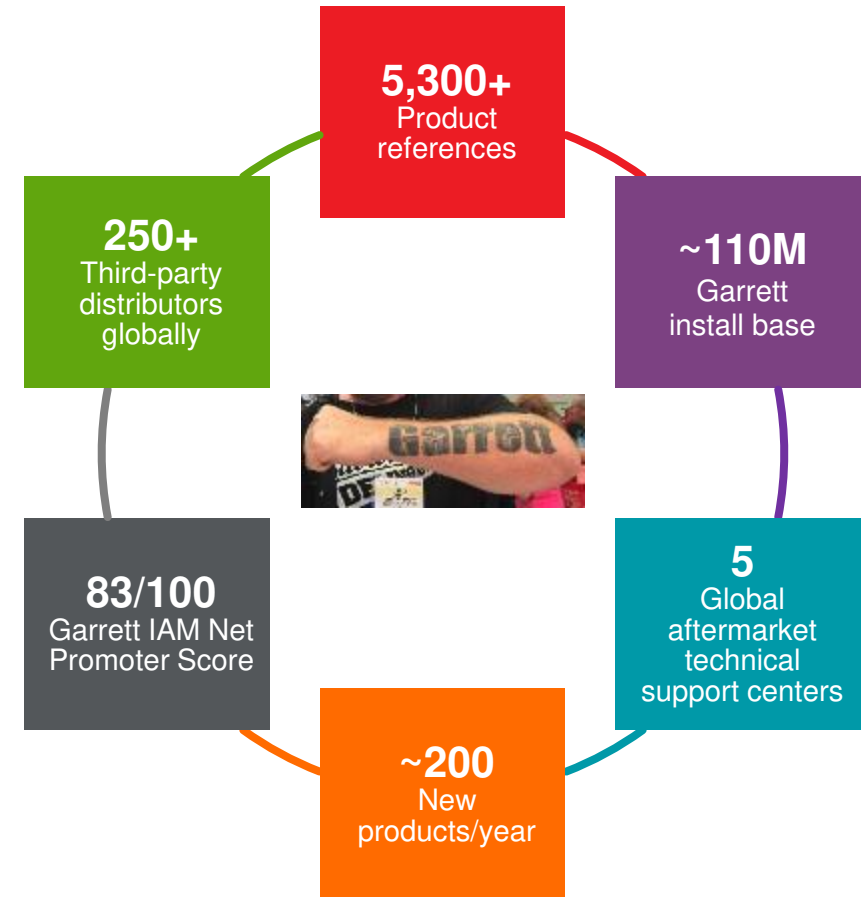

Note: IAM – Independent aftermarket

Garrett aftermarket channels

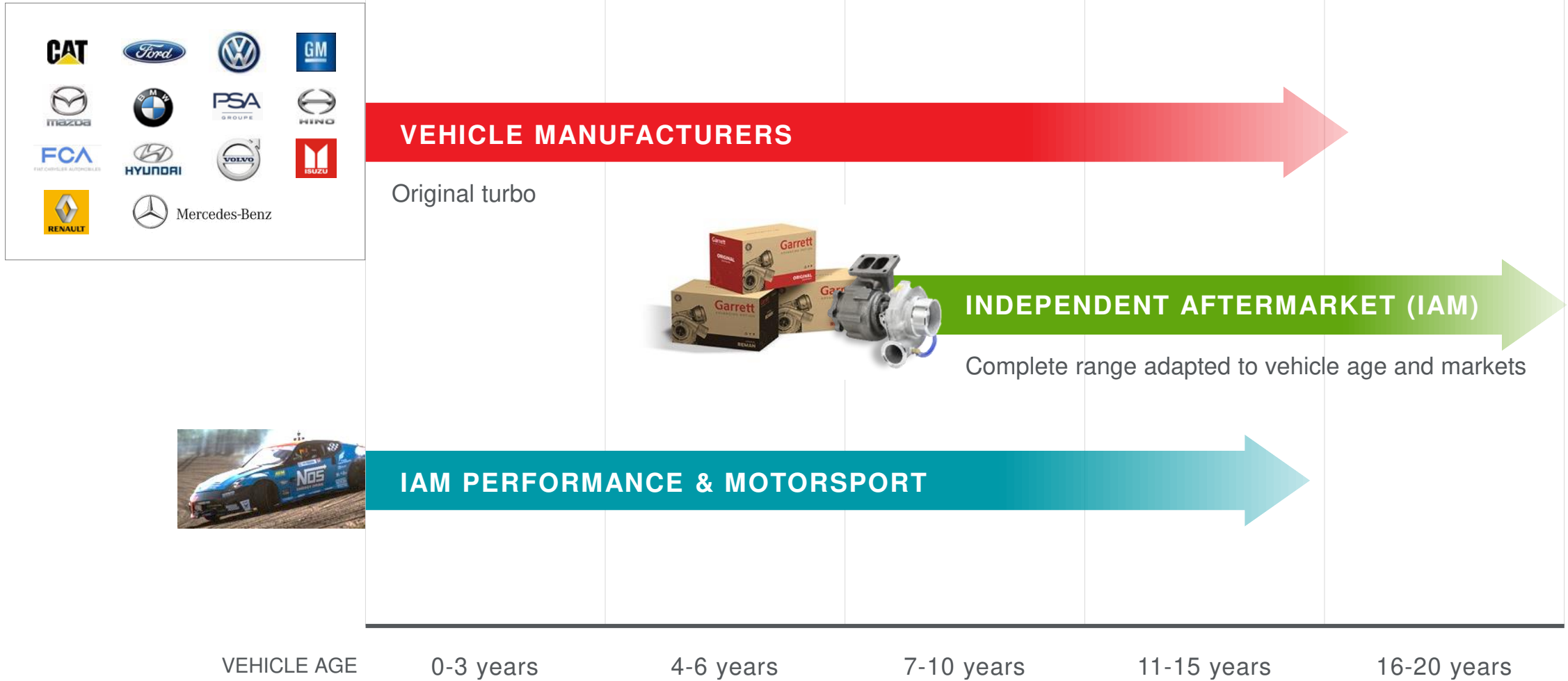

Garrett motorsport technology

Redefining the limits

CUSTOMISED TECHNICAL COMPETENCIES

- **Fuel Cell Compressors:** One and two stage mixed flow compressor stages with oil-less bearing technology to eliminate contamination of FC stack and lowest NVH.
- **Electric Turbos:** Efficiency-optimized turbos combined with high-speed electric machines for max transient (performance) and energy recuperation (fuel efficiency).
- **High-Temperature VNT™ turbos:** Robust 1050°C VNT turbine for both Diesel and Gasoline engines.

Also available:

High-temperature, thin-wall (HK30) turbine housing castings

High-temperature (MarM-247) turbine wheel materials

High efficiency dual row ball bearing cartridges

Lightweight Titanium and Magnesium components

Championship wins

32

FIA World Rally Car
100% since 2002



24

24 Hours of Le Mans
100% since 2000



14

Indianapolis 500

11

CART / Champ Car
67% win rate



10

American Le Mans Series

8

IMSA GTP / GTO



7

FIA World Touring Car
100% since turbo engine rule

7

Global Rallycross
100% since series introduced



9

Super Formula
Turbo engines starting 2014

9

Super GT
Turbo engines starting 2014



8

FIA World Rallycross
Inaugural season 2014

OUR FOCUS ON SUSTAINABILITY



Our sustainability framework starts from our mission

*We Care*4



CLEANER, MORE EFFICIENT VEHICLES

We are cutting-edge technology leader delivering differentiated solutions for emission reduction and energy efficiency



CULTURE OF INNOVATION

We invest in a culture of continuous innovation to deliver on our mission



OPERATING RESPONSIBLY

We operate responsibly to ensure the long-term impact of our mission

We Contribute to a more Sustainable Future



Cleaner, more efficient vehicles

We develop differentiated solutions for sustainable mobility and beyond

>99%

Garrett revenue and R&D in emission reduction and zero-emission technologies

\$1 billion

NEW AMBITION
Revenue from zero-emission solutions by 2030



Culture of Innovation

Our professional global team is at the heart of our success

18% ↑

Increased employee training hours in 2022, reaching 78,000 hours

21.8%

Female representation in 2022, ambition to reach 25% in 2025



Responsible Operations

We operate ethically and drive continuous improvement

46.2% ↓

NEW TARGET:
Science-based CO₂ reduction to 2030 (scope 1+2)

9% ↓

Delivered CO₂ reduction in 2022 (scope 1+2)



WHAT THE REPORT COVERS

- Describes our approach to sustainability
- Garrett's sustainability focus areas and activities
- Our sustainability performance including new science-based carbon target
- [Link to the report](#)



www.garrettmotion.com



| [garrettmotion](#)